

Lithium Manganese Dioxide Coin Battery Brief Data Sheet Model: CR1620

1. Basic Specification (Typical values relative to cells stored for three month at +23°C)

Item	Parameters	Remark
Model	CR1620	Coin type
Nominal Capacity(mAh)	70	at 7.5kΩ ±23°C, 2.0V cut off
Nominal Voltage(V)	3.0	
Continuous Standard Load (kΩ)	7.5	
Operating temperature range(°C)	-20~+60	
Storage temperature(recommended)	+30°C Max.	
Weight(g)	1.3	
Customized a variety of JST/MOLEX/ORTHER etc. connector, terminal. More information, Please contact HJBP power engineer.		

2. Electrical Characteristics and Dimension

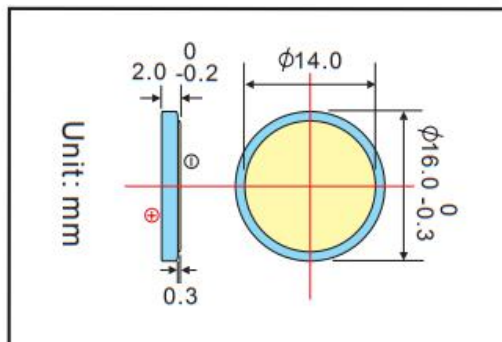
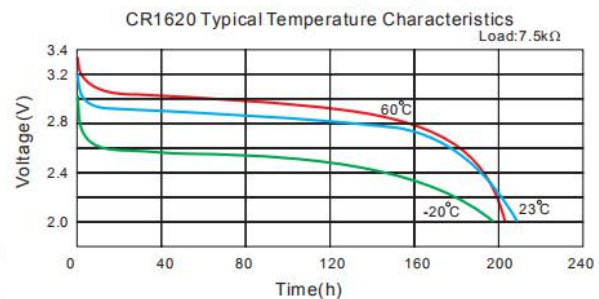
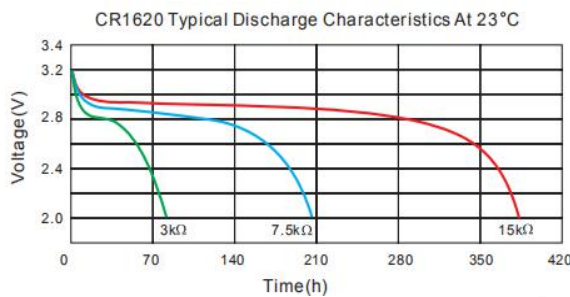

3. Key feature

- ★Light weigh, High voltage, High energy density
- ★Excellent stable discharge characteristics and outstanding temperature characteristics
- ★Excellent leakage resistance and excellent long-term reliability
- ★Low self discharge rate(less than 2% after 1 year of storage at +25°C)
- ★UL1642, CE certification, SGS/ROHS test reporter, ISO19001 quality control system

4. Main application

- ★Utility metering
- ★Automatic meter reading
- ★Automotive electronics
- ★Military electronics
- ★Alarms and security devices
- ★Toy and lighting
- ★Memory back-up
- ★Professional electronics

5. Warning

*Please do not recharge, short-circuit, disassemble, deform, heat or place the battery near a direct flame. Any of the above actions could cause it to ignite explode or become damaged.

*Please keep this battery out of the reach of children.

*When storing the battery or throwing it away, be sure to cover it with tape.

Note: Any representations in this brochure concerning performance, are for informational purposes only and are not construed as warranties either expressed or implied, of future performance.