



Lithium Thionyl Chloride Battery Brief Datasheet Model: ER14250M

1. Basic Specification (Typical values relative to cells stored for one year or less at +30°C Max.)

Item	Parameters	Remark
Model	ER14250M, 1/2A A	Power type
Nominal Capacity(mAh)	750	at 4mA ±23°C, 2.0V cut-off
Nominal Voltage(V)	3.6	3.65V-3.67V
Standard discharge current (mA)	4.0	
Maximum continuous current(mA)	120	
Maximum pulse current(mA)	250	
Operating temperature range(°C)	-55~+85	
Storage temperature(recommended)	+30°C Max.	
Weight(g)	10	
Customized a variety of JST/MOLEX/ORTHER etc. connector , terminal, Please contact HJBP engineer.		

*power type is spiral structure and best suit for medium-large current discharge.

*It may require depassivation before medium currents can be delivered.

2. Electrical Characteristics and Dimension

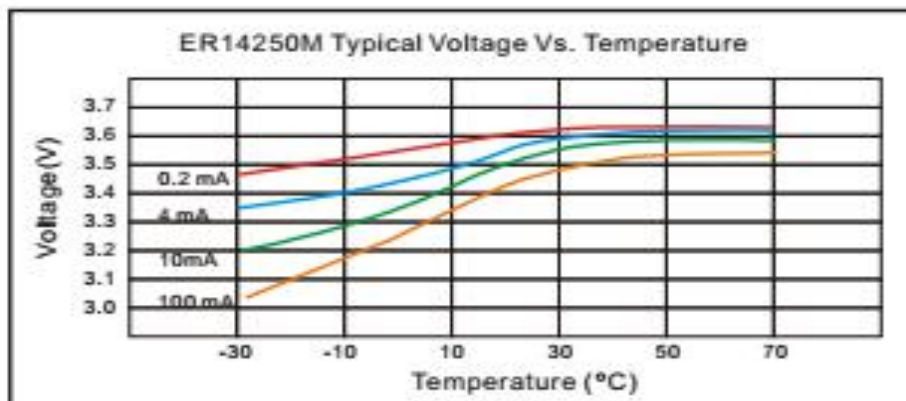
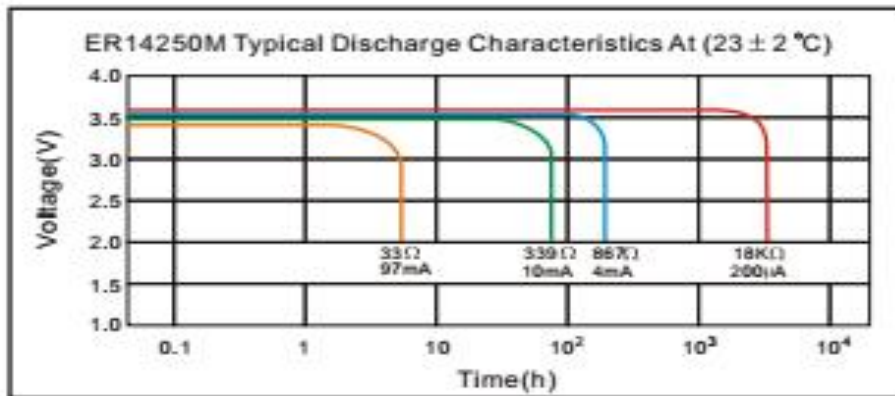

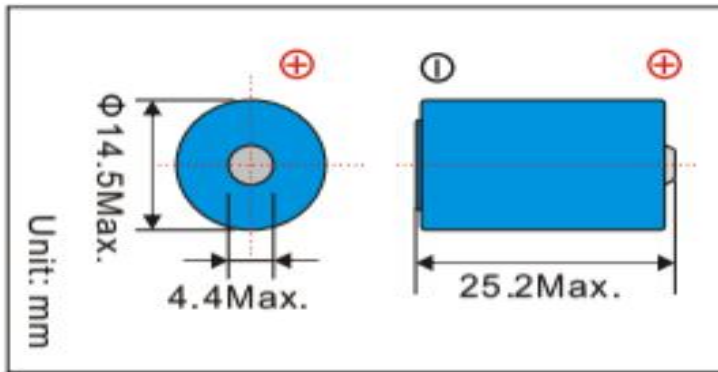
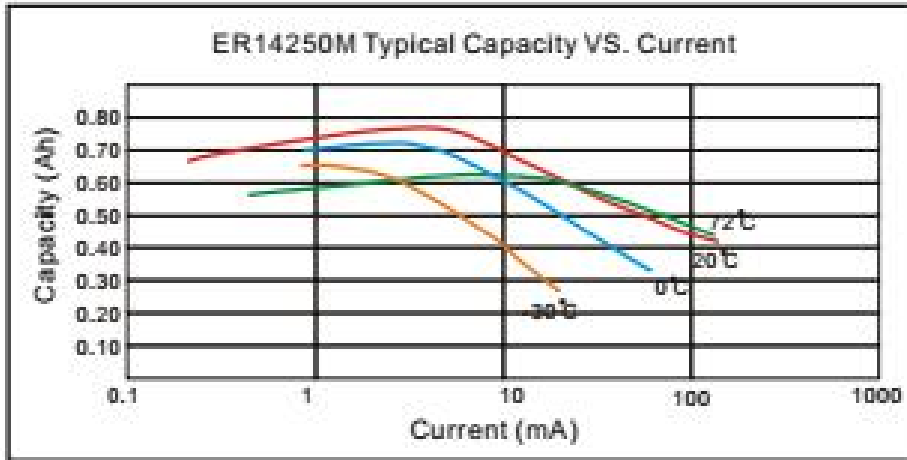

3.Key feature

- ★High and stable operating voltage.
- ★Stainless steel container
- ★Non-flammable electrolyte
- ★Hermetic glass-to-metal sealing
- ★Low self discharge rate(less than 1% after 1 year of storage at +25°C)
- ★UL1642, CE certification, UN38.3, MSDS/SGS/ROHS test reporter,ISO19001 quality control system

4.Main applications

- ★Utility metering
- ★Military electronics
- ★Memory back-up
- ★Automatic meter reading
- ★Alarms and security devices
- ★Professional electronics
- ★Automotive electronics
- ★Tollgates systems

5.Warning

- *Please Keep away Fire,explosion and severe burn hazard.
- *Please Do not recharge,crush,disassemble,heat above 100°C.
- *Please Do not solder directly to cell.

Note: Any representations in this brochure concerning performance,are for informational purposes only and are not construed as warranties either expressed or implied, of future performance.